



E-Car Motor Mount

A. Sheet Metal.

Step 1. Click File Menu > New, click **Part** and OK.

Step 2. Click **Right Plane**  in the Feature Manager and click **Sketch**  from the Content toolbar, **Fig. 1**.

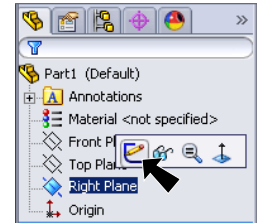



Fig. 1

Step 3. Click **Centerpoint Arc**  in the Arc flyout  on the Sketch toolbar.

Step 4. Click the Origin  to start the arc and move the cursor to the right. Click to place the first end point, then move cursor counterclockwise 180 degrees. Click to place the second end point, **Fig. 2**.

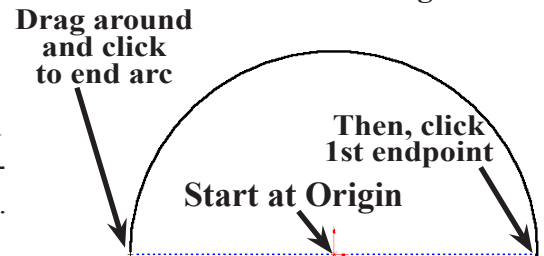

Fig. 2

Step 5. Click **Line**  (L) on the Sketch toolbar.

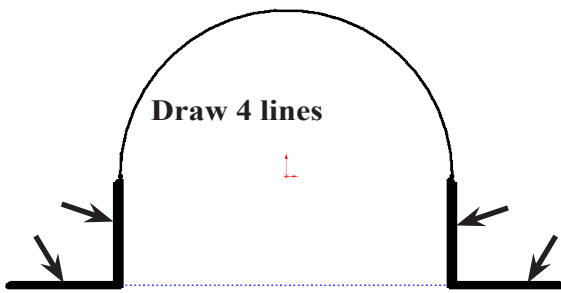

Fig. 3

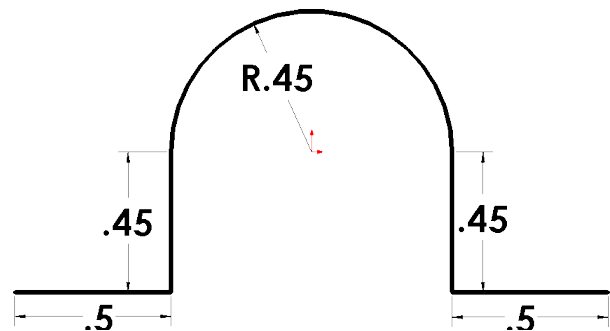

Fig. 4

Step 6. Draw the lines in **Fig. 3**. Start the lines tangent - at the ends of the arc.

Step 7. Click **Smart Dimension**  (S) on the Sketch toolbar.

Step 8. **Dimension the .45 radius first**, then the others dimensions as shown in **Fig. 4**.

Step 9. Click Insert Menu > Sheet Metal > Base Flange.

Step 10. Click **Right**  on the View toolbar. (Ctrl-4)

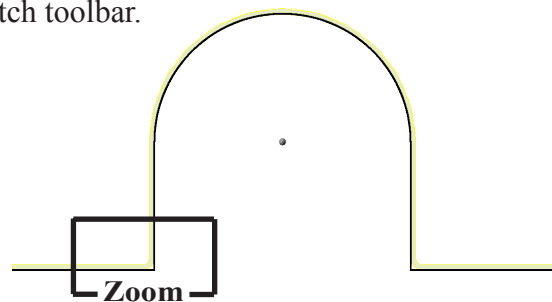



Fig. 5

Step 11. Zoom in around **corner, Fig. 5**. To **zoom**, place the cursor over the corner and spin the wheel on mouse back. While spinning the wheel keep cursor on corner.

- Step 11. In the Property Manager set:
 under **Direction 1**
 select **Mid Plane**, Fig. 7
 Depth  D1 .5
 under **Sheet Metal Gauges**
 check **Use gauge table**
 select **Sample Table - Aluminum**
 under **Sheet Metal Parameters**
 select **Gauge 26**

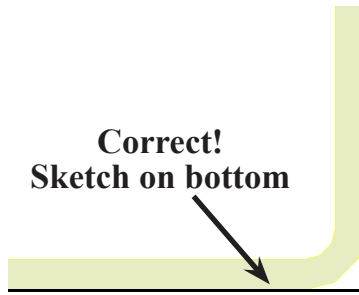

Fig. 6

IF sheet metal, Fig. 6 is on the top of sketch - click OK 

IF sheet metal is on bottom, Fig. 8, check **Reverse direction** in the Property Manager, Fig. 7

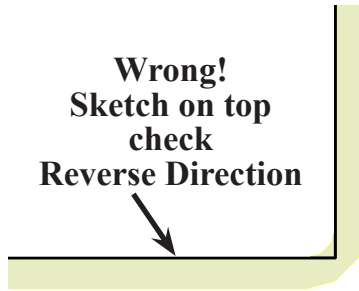

Fig. 8

Sketch (black line) has to be on **bottom** of sheet metal (green part)

click OK 

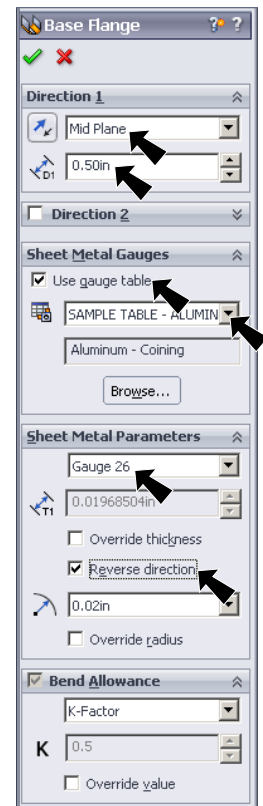

Fig. 7

- Step 12. Click **Isometric**  on the View toolbar. (Ctrl-7)

B. Save as "MOTOR MOUNT".

- Step 1. Click File Menu > Save As.

- Step 2. Key-in **MOTOR MOUNT** for the filename and press ENTER.

C. Holes.

- Step 1. Click the **top face** and click **Sketch**



on the Content toolbar, Fig. 9.

- Step 2. Click **Normal To**  on the Views toolbar (Ctrl-8).

- Step 3. Click **Circle**  on the Sketch toolbar.

- Step 4. Draw **two circles** for the holes, Fig. 10.

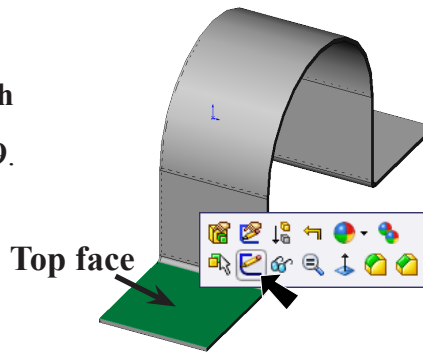

Fig. 9

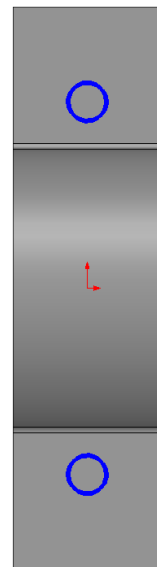

Fig. 10

Step 5. Click **Smart Dimension**  on the Sketch toolbar.

Step 6. Add dimensions as shown in **Fig. 11**. To Smart dimension circle distance from Origin, click circle and click Origin, then move cursor out away and click to place dimension. Key-in the dimension and press ENTER. Arrange the dimensions as shown in **Fig. 11**.

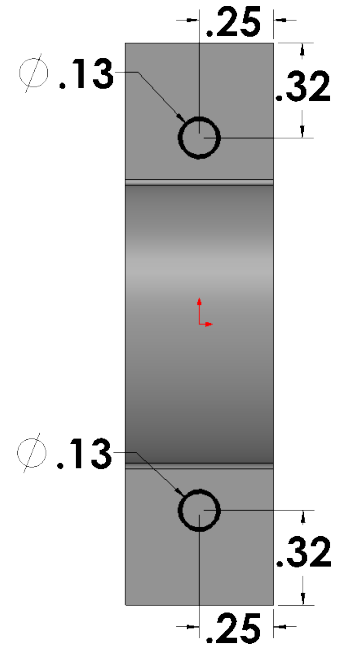
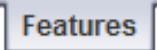



Fig. 11

Step 7. Click **Features**  on the Command Manager toolbar.

Step 8. Click **Extruded Cut**  on the Features toolbar.

Step 9. Click **Isometric**  on the View toolbar. (Ctrl-7)

Step 10. In the Property Manager set:
 under Direction 1, **Fig. 12**
 EndCondition **ThroughAll**
 click OK , **Fig. 13**.

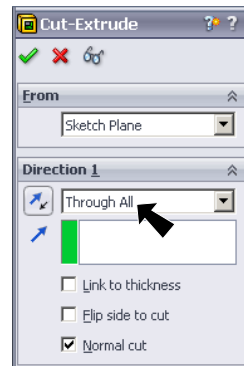

Fig. 12

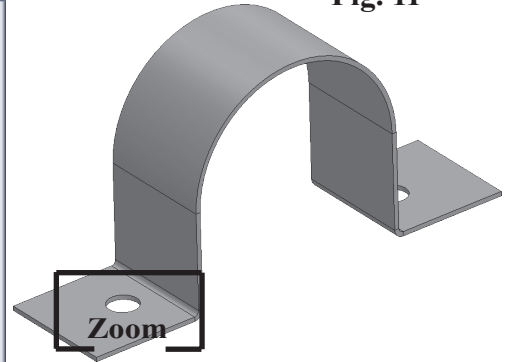



Fig. 13

D. Mate Reference.

Step 1. Zoom in around **front hole in Motor Mount, Fig. 13**. To zoom, place the cursor over the hole and spin the wheel on mouse back. While spinning the wheel keep cursor on hole.

Step 2. Click the **bottom circular edge of hole** to select edge, **Fig. 14**.

Step 3. Click **Reference Geometry**  on the Features toolbar and **Mate Reference** from the menu.

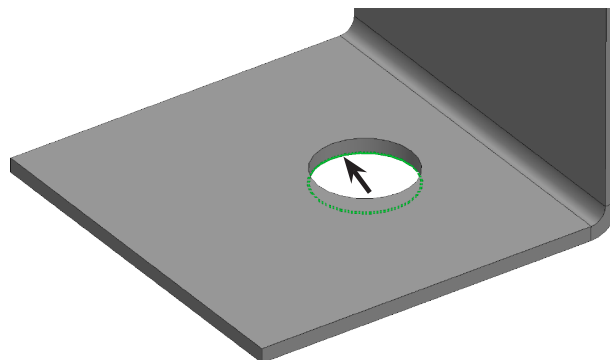



Fig. 14

Step 4. In the Mate Reference Property Manager click OK , **Fig. 15**.

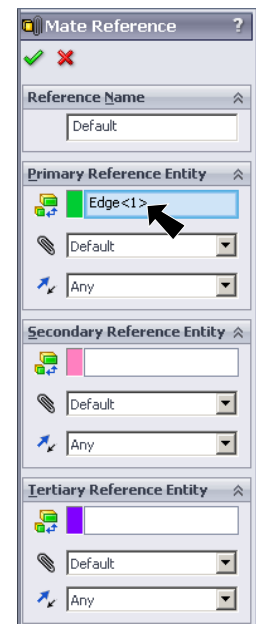

Fig. 15

Step 5. Click **Zoom to Fit**  (F) on the View toolbar.

E. Chamfers.

Step 1. Click **Chamfer**  in the **Fillet flyout**  on the Features toolbar.

Step 2. In the Chamfer Property Manager set:

Depth  D1 .1

Angle  45°, Fig. 16

Drag a selection around each corner to select the corner vertical edge, Fig. 17. Click OK .

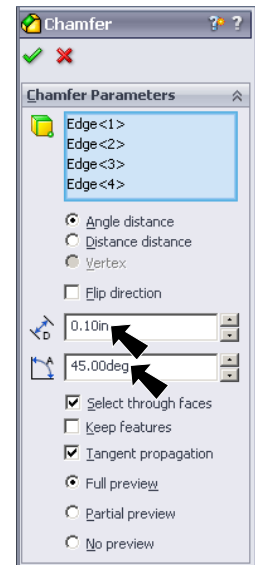

Fig. 16

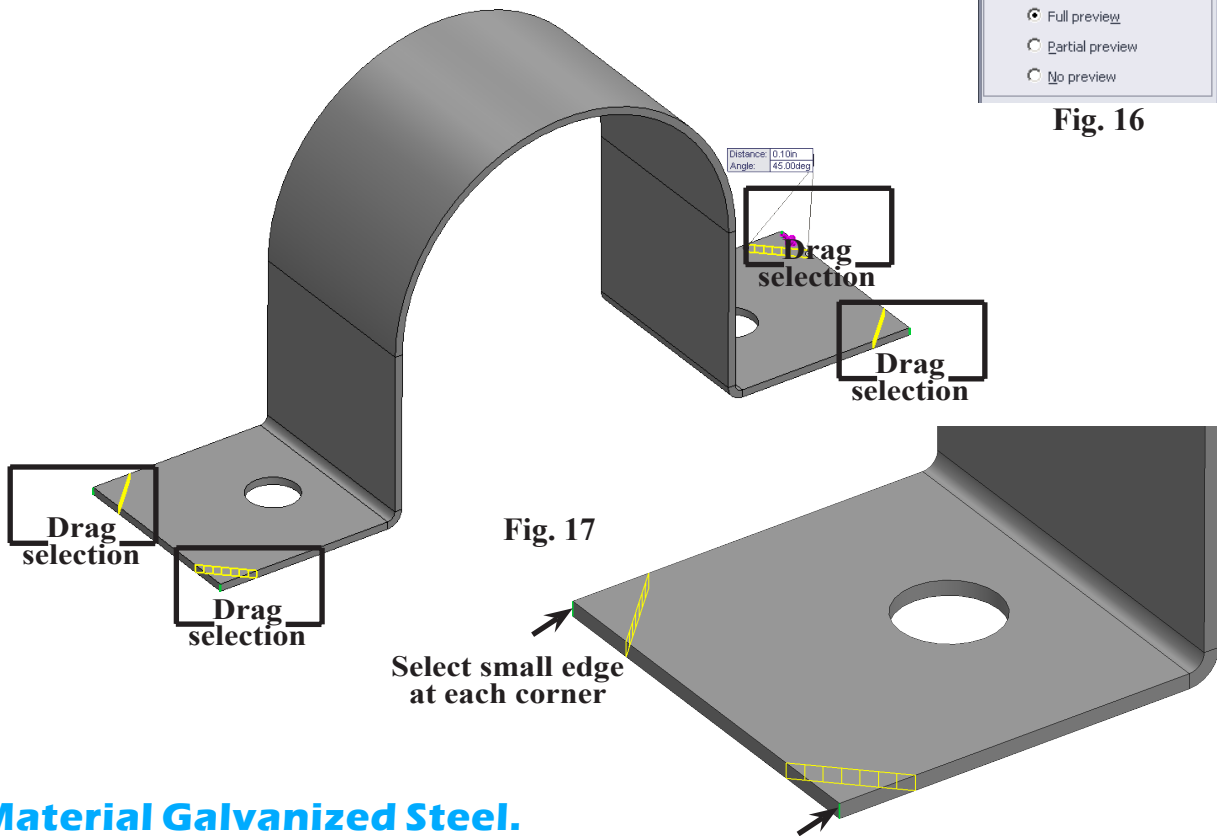



Fig. 17

F. Material Galvanized Steel.

Step 1. Right click **Material**  in the Feature Manager and click **Edit Material**.

Step 2. Expand **Steel** in the material tree and click **Galvanized Steel**. Click **Apply** and **Close**.

Step 3. Save. Use **Ctrl-S**.

