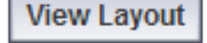


# CO2 Shell Car Drawing

## A. Insert Views.

Step 1. Click File Menu > New, click **Drawing Metric** and OK.

Step 2. Click **View Layout**  on the Command Manager toolbar.

Step 3. Click **Model View**  on the View Layout toolbar.

Step 4. Click **Browse** in the Property Manager.

Step 5. Select your **SHELL CAR ASSEMBLY** file and click Open.

Step 6. In the Property Manager under **Orientation**:

click **Right** 

check **Preview**

under **Scale**

click **Use custom scale** and set scale to **1:1**, Fig. 1.

Step 7. Move the cursor into the graphic area. Align the left edge of the preview with the left border line. Center preview between top border line and top of the title block. Click to place as shown in Fig. 2.

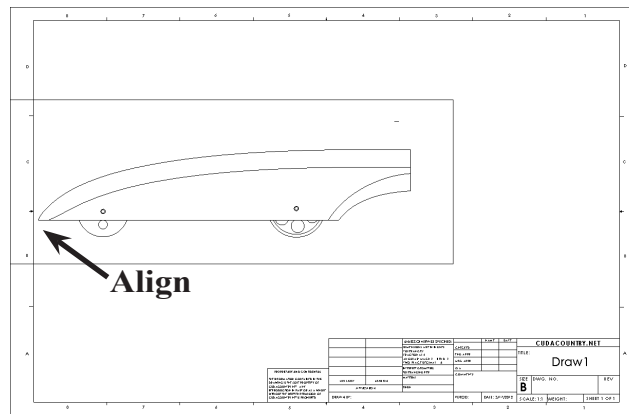


Fig. 2

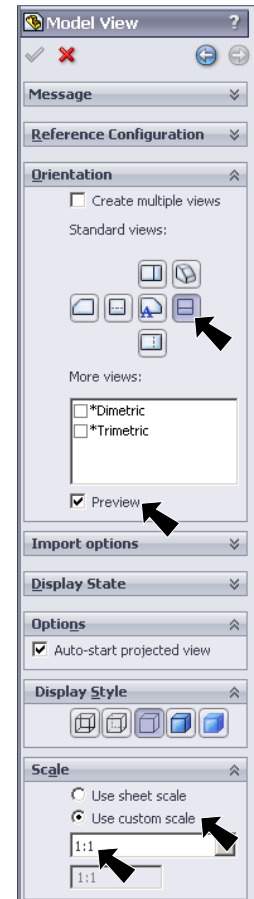


Fig. 1

Step 8. **Move cursor straight up.** Center preview between the side view you just placed and top border line. Click to place the top view as shown in Fig. 3.

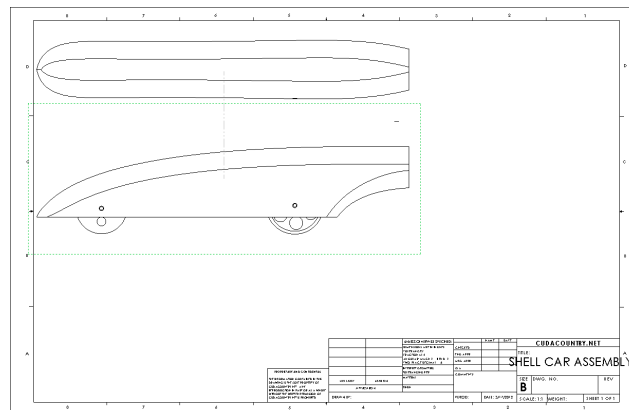
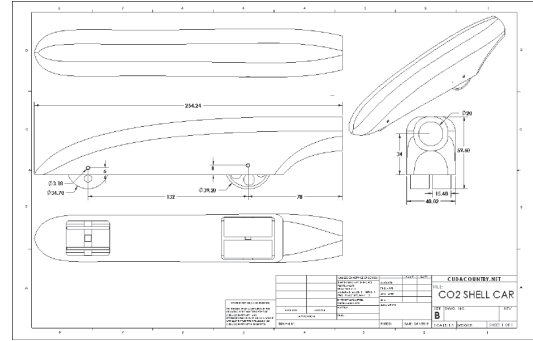
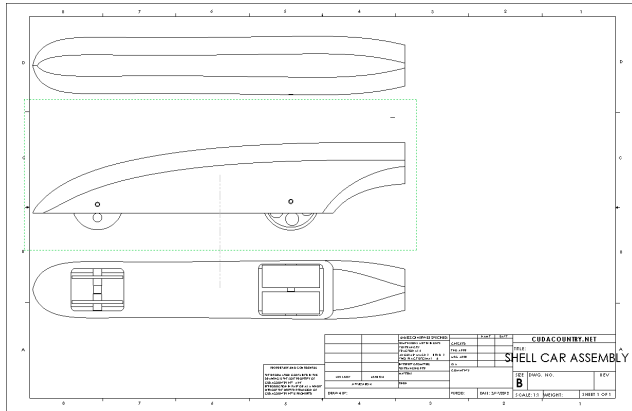


Fig. 3

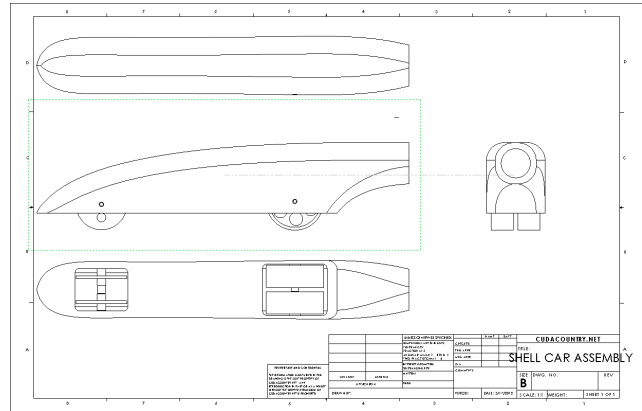


Step 9. Move the cursor straight down below the side view. Center the preview between the side view and top of title block. Click to place the bottom view as shown in **Fig. 4**.

Step 10. Move the cursor to the right of the side view. Center the preview between the side view and right border line. Click to place the back view as shown in **Fig. 5**.

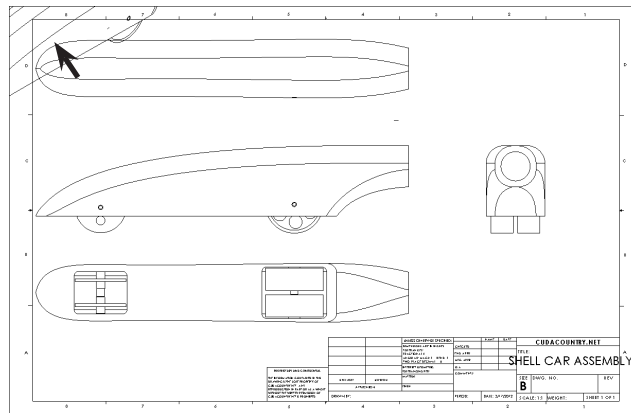


**Fig. 4**



**Fig. 5**

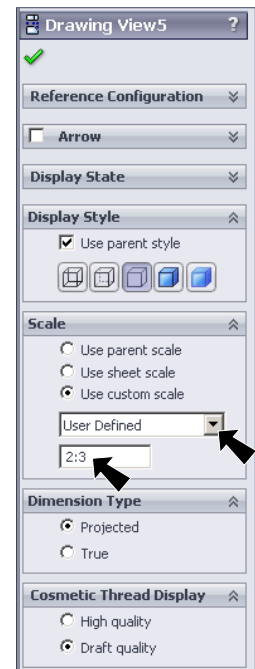
Step 11. Move the cursor to the top left corner of the drawing and click to place the Isometric view, **Fig. 6**.



**Fig. 6**

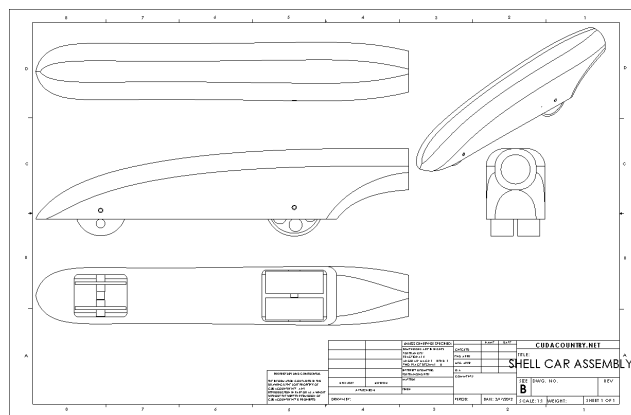
Step 12. Click OK  in the Property Manager.

Step 13. Click the Isometric view to select it, **Fig. 6**. In the Property Manager under Scale, select **User Defined** and key-in **2:3**, **Fig. 7**.



**Fig. 7**

Step 14. Grab any geometry of the Isometric view and move view to top right corner of drawing, **Fig. 8**.




**Fig. 8**

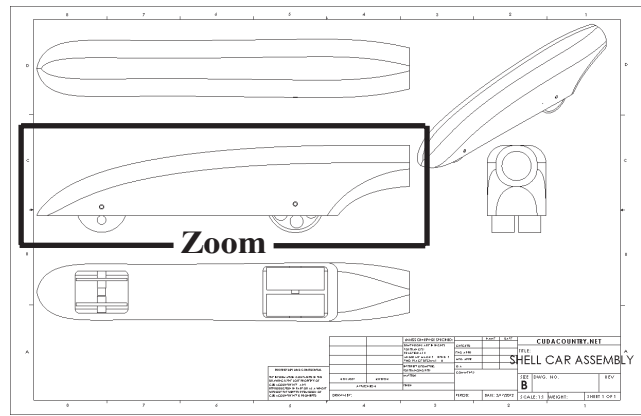
## **B. Save as "CO2 SHELL CAR".**

Step 1. Click File Menu > Save As.


Step 2. Key-in **CO2 SHELL CAR** for the filename and press ENTER.

### C. Add Dimensions.

Step 1. Use the **Zoom to Area**  in the View toolbar to drag a zoom window around the **side view**, **Fig. 9**.

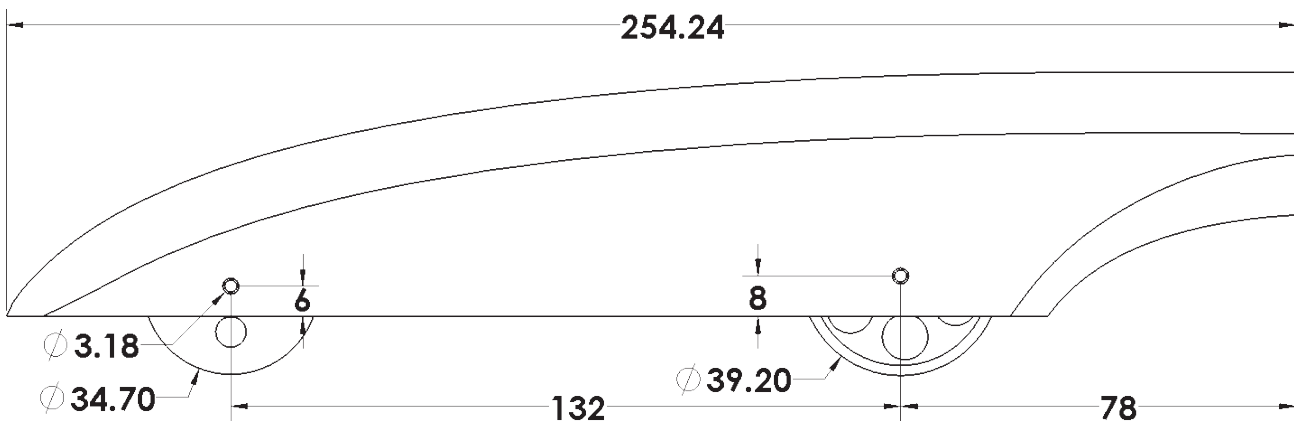


**Fig. 9**


Step 2. Click **Sketch**  on the Command Manager toolbar.

Step 3. Click **Smart Dimension**  (S) on the Sketch toolbar.

Step 4. Add the dimensions to the side view as shown in **Fig. 10**. To Smart dimension click the line then move the cursor out away from the line and click. Arrange the dimensions as **Fig. 10**. **You can only place dimensions here- you can not change dimensions.** To dimension an axle or wheel diameter, click circle, then move the cursor away from the circle and click.

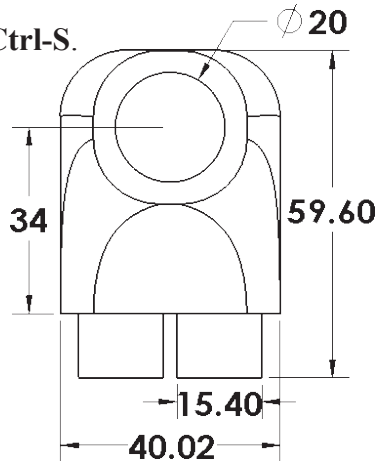


**Fig. 10**

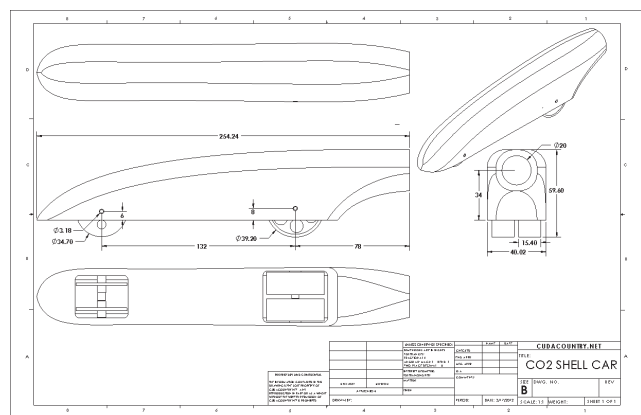
Step 5. Use **F** key on keyboard to **fit** drawing. Use the **Zoom to Area**  in the View toolbar to drag a zoom window around the **back view**. Escape to unselect Zoom to Area.

Step 6. Add the dimensions to the **back view** as shown in **Fig. 11**.

Step 7. Save. Use **Ctrl-S**.




**Fig. 11**

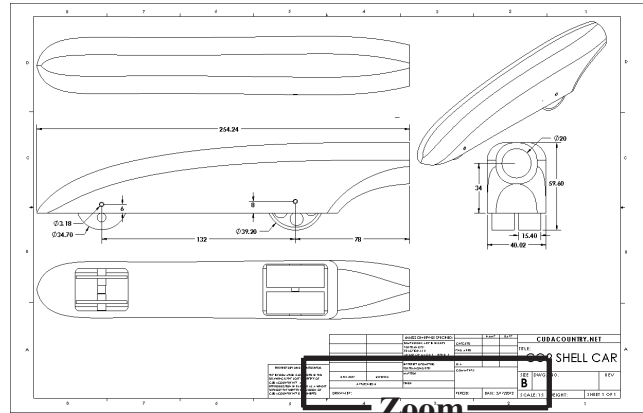


**Fig. 12**


## D. Add Your Name and Period to Title Block.

Step 1. Use **F** key on keyboard to **fit** drawing.

Use the **Zoom to Area**  in the View toolbar to drag a zoom window around the **DRAWN BY** and **PERIOD** in the title block, **Fig. 13**.

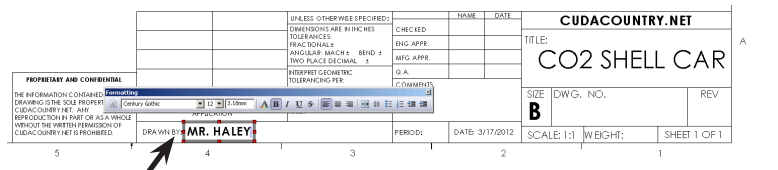


**Fig. 13** Zoom

Step 2. Click **Note**  on the Annotation toolbar.

Step 3. Click just to the right of **DRAWN BY**;, **Fig. 14**.

Step 4. Lock the Caps and key-in **your first and last names**, **Fig. 15**.



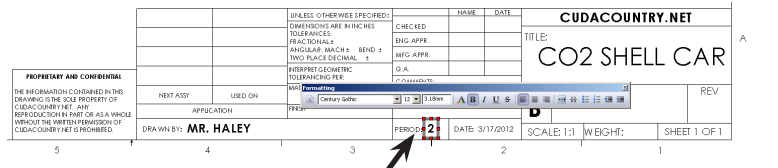
**Fig. 14**

Step 5. Click **OK**  in the Property Manager.

Step 6. Click **Note**  on the Annotation toolbar.

Step 7. Click just to the right of **PERIOD**:, click and key-in **your Period number**, **Fig. 15**.

Step 8. Click **OK**  in the Property Manager.



**Fig. 15**

Step 9. Save. Use **Ctrl-S**.