



A. Sketch.

Step 1. Click File Menu > New, click **Part Metric** and OK.

Step 2. Click **Front Plane**  in the Feature Manager and click **Sketch**  from the Content toolbar, **Fig. 1**.

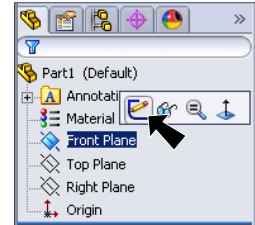



Fig. 1

Step 3. Click **Line**  (L) on the Sketch toolbar.

Step 4. Starting at the Origin , draw lines shown in **Fig. 2**.

Step 5. Click **Smart Dimension**  (S) on the Sketch toolbar.

Step 6. Dimension as shown in **Fig. 3**. Start dimensioning from the bottom corner dimension, the 3 and work around the sketch, that is, dimension the 3, then 17.35, 1 and 5.75 last.

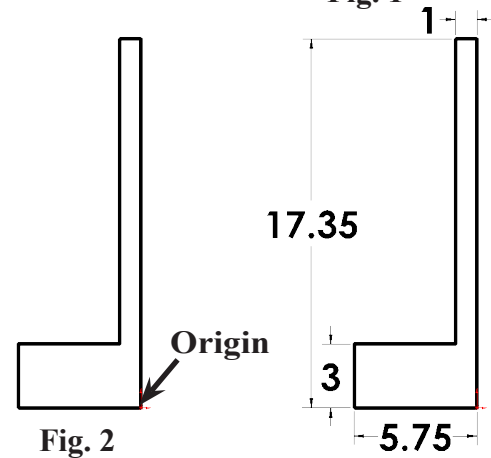



Fig. 2

Fig. 3

Step 7. **Right click drawing and click Select** from menu to unselect Smart Dimension.

Step 8. Click **right vertical line** and click **Construction Geometry**  on the Content menu, **Fig. 4**.

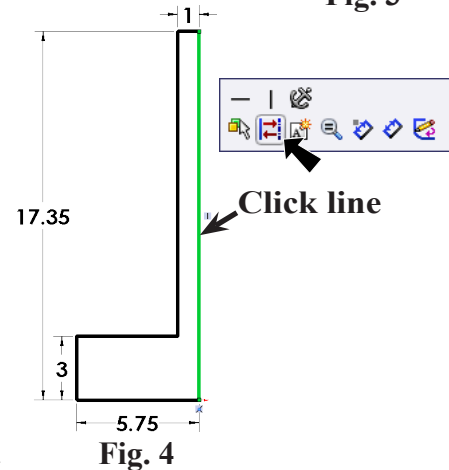

Fig. 4

Step 9. **Drag selection around the sketch** to select all entities (lines and dimensions), **Fig. 5**. To drag selection, click above and to left of sketch and drag down and to right to drag around all.

Step 10. Click **Mirror Entities**  on the Sketch toolbar, **Fig. 6**.

B. Save as "WHEEL GT-F".

Step 1. Click File Menu > Save As.

Step 2. Key-in **WHEEL GT-F** for the filename and press ENTER.

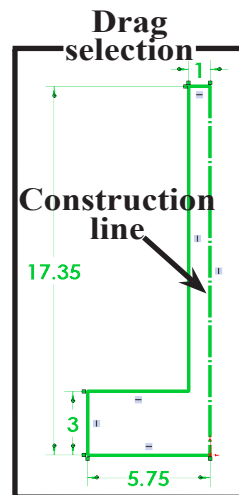

Fig. 5

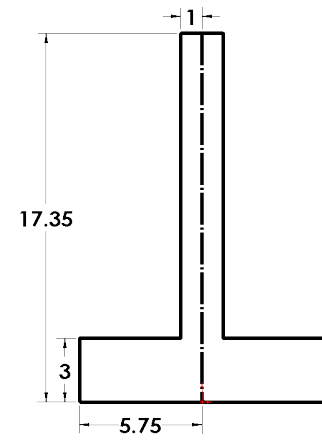
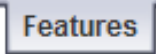

Fig. 6

C. Revolve.

Step 1. Click **Features**  on the Command Manager toolbar.

Step 2. Click **Revolved Boss/Base**  on the Features toolbar.



Step 3. In the Revolve Property Manger:
 for Axis of Revolution ,
 click **bottom line of sketch**, **Fig. 8**
 click OK .



Fig. 7

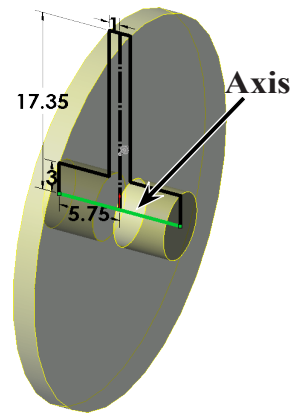



Fig. 8

Step 4. Click Zoom to Fit  (F) on the View toolbar.

D. Hole for Axle.

Step 1. Click the **side face of hub** and click **Sketch**  on the Content menu, **Fig. 9**.

Step 2. Click **Normal To**  on the Standard Views toolbar. (Ctrl-8)

Step 3. Click **Circle**  (S) on the Sketch toolbar.

Step 4. Draw a circle for the hole starting at the Origin , **Fig. 10**.

Step 5. Click **Smart Dimension**  (S) on the Sketch toolbar.

Step 6. Dimension the axle hole **3.5** as shown in **Fig. 10**.

Step 7. Click **Features**  on the Command Manager toolbar.

Step 8. Click **Extruded Cut**  on the Features toolbar.

Step 9. Click **Isometric**  on the Standard Views toolbar.

Step 10. In the Property Manager set:
End Condition to Through All
 click OK , **Fig. 11** and **Fig. 12**.

Step 11. Save. Use **Ctrl-S**.

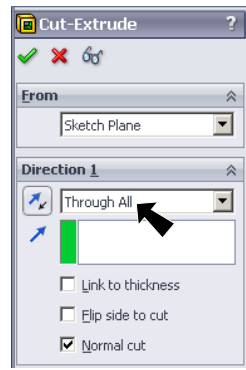

Fig. 11

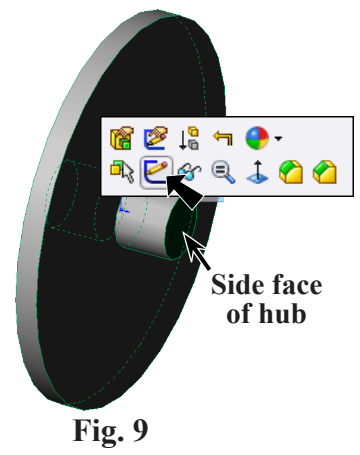

Fig. 9

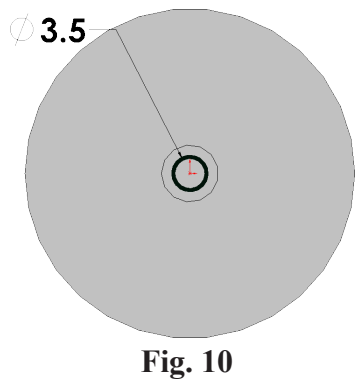

Fig. 10

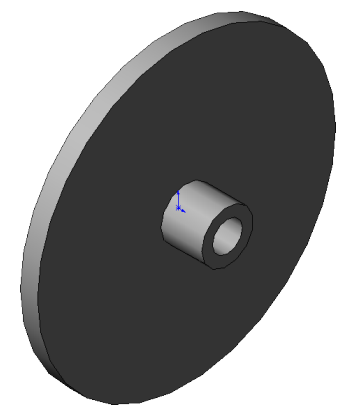





Fig. 12

E. Hole in Rim.

Step 1. Click the **side face of wheel** and click **Sketch**  on the Content menu, **Fig. 13**.

Step 2. Click **Normal To**  on the Standard Views toolbar. (**Ctrl-8**)

Step 3. Click **Circle**  (S) on the Sketch toolbar.

Step 4. Draw a circle for the hole directly **above** the Origin  , **Fig. 14**. Use the inferencing line, the dotted line that appears when you draw the circle.

Step 5. Click **Smart Dimension**  (S) on the Sketch toolbar.

Step 6. Dimension as shown in **Fig. 14**.

Step 7. Click **Features**  on the Command Manager toolbar.

Step 8. Click **Extruded Cut**  on the Features toolbar.



Step 9. Click **Isometric**  on the Standard Views toolbar. (**Ctrl-7**)

Step 10. In the Property Manager set:
End Condition to **Through All**
click OK  , **Fig. 15** and **Fig. 16**.

F. Circular Pattern for Hole.

Step 1. Click View Menu > Temporary Axes. (**Alt-V X**)

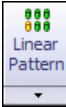
Step 2. Click **Cut-Extrude2** in the Feature Manager (left panel) to select the hole in the wheel, **Fig. 17**.

Step 3. Click **Circular Pattern**  **Circular Pattern** in the **Linear Pattern flyout**  on the Features toolbar. Be sure to click the **flyout arrow**  to select Circular Pattern.

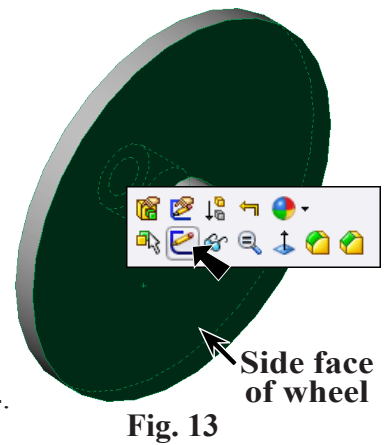

Fig. 13

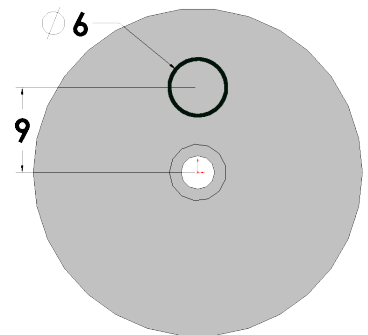

Fig. 14

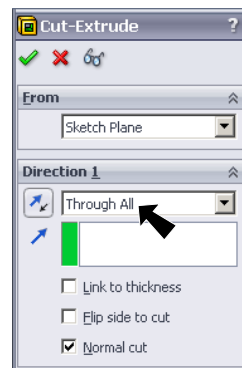

Fig. 15

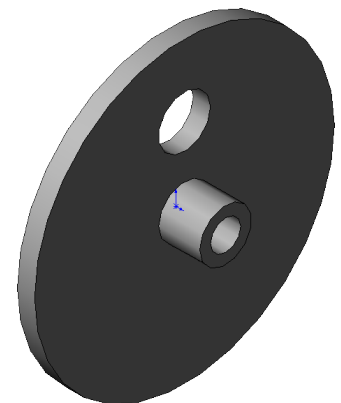

Fig. 16

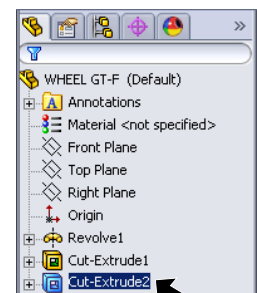



Fig. 17

Step 4. In the Circular Pattern Property Manager set:
under Parameters

click in the **Pattern Axes**  box, **Fig. 19**
click **Temporary Axis** in drawing, **Fig. 18**

Number of Instances  to 4, **Fig. 19**
check **Equal spacing**

under **Options**
check **Geometry pattern**

click OK .

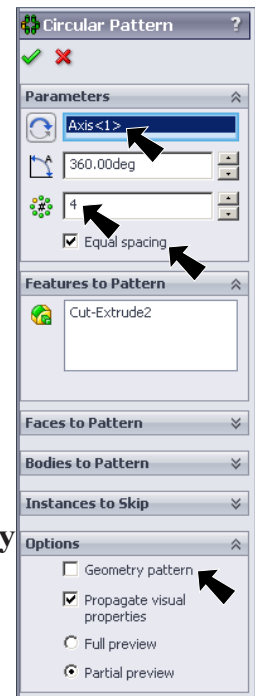
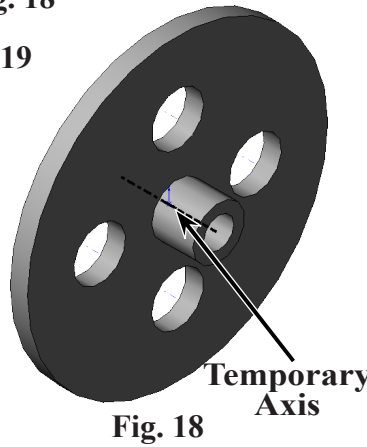

Step 5. **Turn off** Temporary Axes. Click View
Menu > Temporary Axes. (Alt-V X)

G. Mate Reference.

Step 1. Click the **inside cylindrical face of axle hole** to select it, **Fig. 20**.

Step 2. Click **Reference Geometry**  on the
Features toolbar and **Mate Reference** from
the menu.

Step 3. In the Mate Reference Property Manager
click OK , **Fig. 21**.

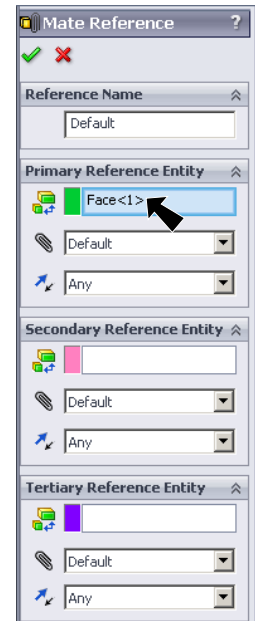
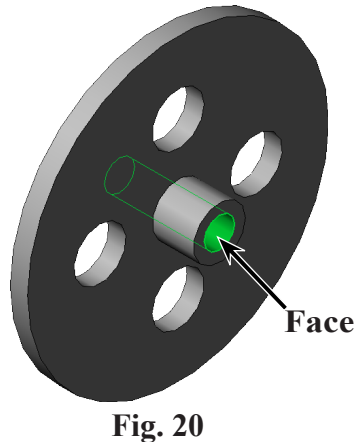

H. Material POM Acetal Copolymer.

Step 1. Right click Material  in the Feature Manager and click Edit Material, Fig. 22.

Step 2. Expand Plastics in the material tree and select POM Acetal Copolymer, Fig. 23. Click Apply and Close.

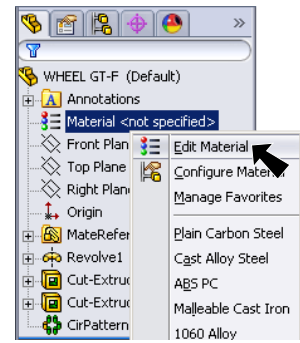





Fig. 22

I. Appearance Dark Gray.

Step 1. Click the part, click Appearance Callout

 on the Content menu and click WHEEL GT-F , Fig. 24.

Step 2. In the Appearances Task Pane, expand Plastic and click High Gloss, Fig. 25.

Step 3. In the lower pane click dark gray high gloss plastic, Fig. 25 and click OK  in the Property Manager.

Step 4. Save. Use Ctrl-S.

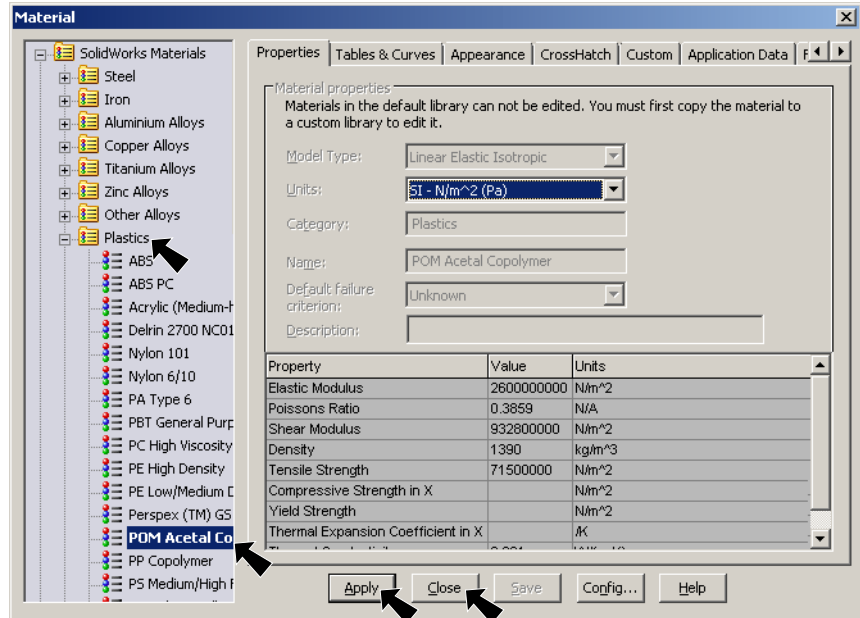

Fig. 23

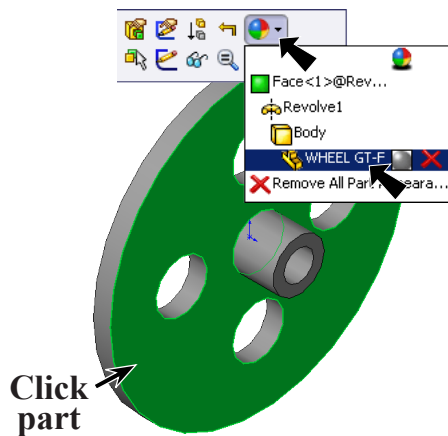

Fig. 24

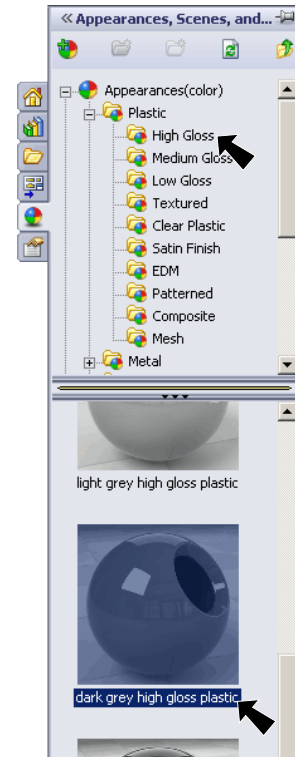

Fig. 25

